

3 valve positions only in conjunction with a second way-valve.

Operating pressure: 2.5 to 10 bar  
Max. vacuum 10 bar (external pilot air)

Temperature range: -10 °C to +60 °C

Body and piston: Aluminium

Seal: NBR

Spring: Special steel









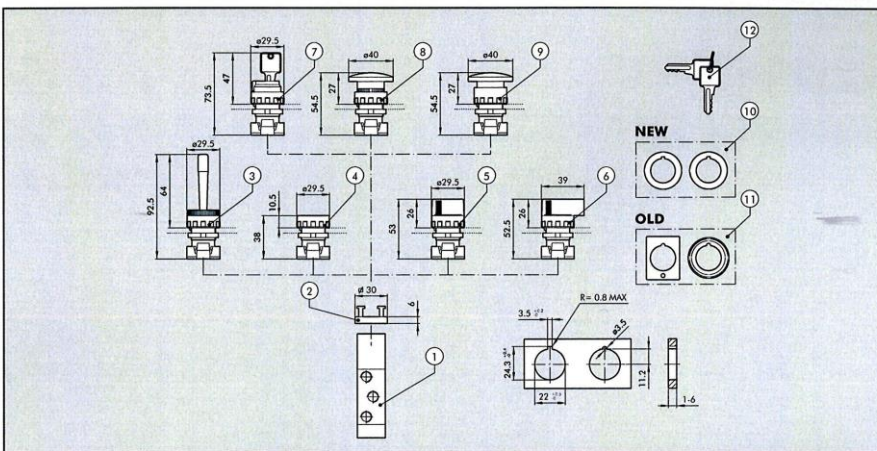







Flow rate at 6 bar and  $\Delta$  0.5 bar: 400 NI/min.

Flow rate at 6 bar and  $\Delta$  1.0 bar: 550 NI/min.



ASSEMBLY DIAGRAM FOR PILOT-ASSISTED HAND-OPERATED VALVES SERIES 70 WITH PANEL ACTUATORS



ORDERING CODES				
Symbol	Reference	Description	Code	Weight [g]
	①	Pilot-assisted plunger 3/2, 1/8"	-	124
	①	Pilot-assisted plunger 5/2, 1/8"	515.211 bis 515.711	150
	②	2 places adaptor thickness 6.8 mm	-	5
	③	Red handler with horizontally pivoted lever	515.311	25
	④	Fat push button + 2 red/black coloured disks ◆ Bistable fat push button without disk	515.211	15
	⑤	Black selector short lever at 2 positions with return	515.411	20
	⑤	Black selector short lever at 2 positions	515.412	20
	⑤	Black selector short lever at 3 positions with return	515.413	20
	⑤	Black selector short lever at 3 positions	515.414	20
	⑥	Black selector long lever at 2 positions with return	515.511	26
	⑥	Black selector long lever at 2 positions	515.512	26
	⑥	Black selector long lever at 3 positions with return	515.513	26
	⑥	Black selector long lever at 3 positions	515.514	26
	⑦	2 positions key selector with extractable key in 2 positions		50
	⑦	2 positions key selector with extractable key in 0		50
	⑧	Red mushroom-head push button ø40	515.611	27
	⑧	Black mushroom-head push button ø40		27
	⑨	Red mushroom-head push button with lock ø40	515.711	29
	⑩	◆ Reducer from 30 to 22.5 mm		
	⑪	▲ Adaptor for bore ø30 G2326		
	⑫	◆ key for ESC selectors		
		Green disk for push button ④		

◆ It can't be supplied. As working replaced by selector with bistable short lever at 2 positions ⑤  
◆ Usable only with technopolymer body selectors  
▲ Usable only with metal body selectors

**PILOT-ASSISTED PLUNGER 5/2 1/8" FOR PANEL ACTUATORS**

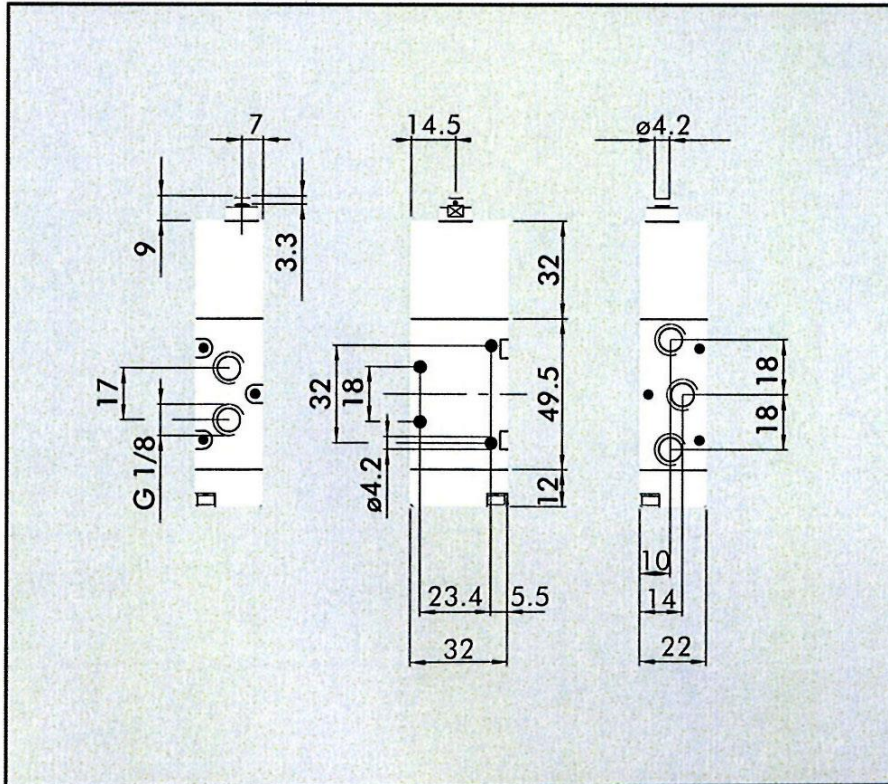

Symbol	Abbrev.	Code	Weight [g]
	MAV 25 BRE OO	515.211	150
		bis	
		515.711	

Type No.	Art. No.
515.211	106429
515.311	106430
515.411	106431
515.511	106435
515.611	106439
515.711	106440